

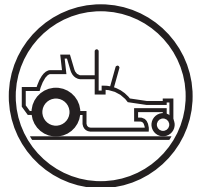

Husqvarna[®]

English



Operator Manual

Z254F / 96768100200

Please read the operator manual carefully and make sure you understand the instructions before using the machine.

Gasoline containing a maximum of 10% ethanol (E10) is permitted for use in this machine. The use of gasoline with more than 10% ethanol (E10) will void the product warranty.



CONFORMITY CERTIFICATES

USA requirements

Labels are placed on the engine and/or in the engine compartment stating that the machine will fulfill the requirements. This is also applicable to special requirements for any of the states, (California emission rules etc.). Do not remove these labels. Certificates can also be supplied with the machine at delivery or written in the Engine manual. Take care of them as they are valuable documents.

 **WARNING!** Failure to follow cautious operating practices can result in dangerous injury to the operator or other persons. The owner must understand these instructions, and must let only approved persons who understand these instructions to operate the mower.

Each person operating the mower must be of sound mind and body and must not be under the influence of mind altering substances.

 **WARNING!** Engine exhaust, some of its constituents, and certain vehicle components contain or emit chemicals known to the State of California to cause cancer and birth defects or other reproductive harm.

 **WARNING!** Battery posts, terminals and related accessories contain lead and lead compounds, chemicals known to the State of California to cause cancer and birth defects or other reproductive harm. Clean your hands after handling.

 **WARNING!** Engine exhaust and certain vehicle components contain or emit chemicals considered to cause cancer, birth defects, or other reproductive system damage. The engine exhaust contains carbon monoxide, which is an odorless, colorless, poisonous gas. Do not use the machine in enclosed spaces.

When this product is worn out and no longer used, return it to the reseller or other party for recycling.

To implement improvements, specifications and designs can be altered without prior notification.

Use only original parts for repairs. The use of other parts voids the warranty.

Do not modify or install non-standard equipment to the unit without consent from the manufacturer. Modifications to the unit may cause unsafe operations or damage the unit.

CONTENTS

INTRODUCTION	4	OPERATION	16
Driving and Transport on Public Roads	4	Training	16
Towing	4	Operating on Hills	17
Operating	4	Moving Machine By Hand	18
SYMBOLS AND DECALS	6	MAINTENANCE	19
SAFETY	7	Battery	21
Protecting Children	7	Safety System	22
Personal Safety Equipment	8	Park Brake	22
Slope Operation	8	Tire Pressures	22
Safe Handling of Gasoline	9	Caster Wheels	23
Transport	10	V-belts	23
Spark Arrestor	10	Adjusting the Mower Deck	23
CONTROLS	11	Cutting Blades	24
Steering Control Levers	12	Anti-scalp Rollers	25
Park Brake	12	Cleaning	25
Throttle Control	12	LUBRICATION	26
Ignition Switch	13	Engine Oil	27
Service Meter	13	Wheel and Deck Zerks	27
Blade Switch	13	Transmission	27
Choke Control	13	TROUBLESHOOTING	28
Fuse	13	STORAGE	29
Cutting Height Lever	13	SCHEMATIC	30
Seat Adjustment Lever	14	TECHNICAL DATA	31
Bypass Linkages	14	SERVICE JOURNAL	33
Fuel Shut Off Valve	14		
Tracking	14		
Fuel Tank	15		

INTRODUCTION

Congratulations

Thank you for purchasing a Husqvarna ride-on mower. This machine is built for superior efficiency to rapidly mow primarily large areas. A control panel that the operator can easily access and a hydrostatic transmission regulated by steering controls each contribute to the machine's performance.

This manual is a valuable document. Read the contents carefully before using or servicing the machine. The following of instructions (use, service, maintenance) by all who operate this machine is important for the safety of the operator and others. It can also largely increase the life span of the machine and increase its resale value.

If you sell your machine, be sure to give the operator manual to the new owner.

The last chapter of this operator manual supplies a Service Journal. Make sure that service and repair work are documented. A correctly kept service journal reduces service costs for the maintenance and affects the machine's resale value. Please contact your dealer for more information. Take the operator manual along when the machine is taken to your dealer for service.

General

In this operator manual, left and right, rearward and forward are used in relation to the machine's usual driving direction.

Continuous dedication to make our products better requires that specifications and design are subject to change without notice.

Driving and Transport on Public Roads

Check applicable road traffic regulations before transporting on public roads. If the machine is transported, you must always use approved fastening equipment and make sure that the machine is correctly attached. DO NOT operate this machine on public roadways.

Towing

If machine is equipped with a tow hitch, use much more care when towing. Do not let children or others in or on the towed equipment. Make wide turns to avoid jack-knifing. Travel slowly and leave more distance to stop.

Do not tow on sloped ground. The weight of the towed equipment can cause loss of traction and loss of control.

Obey the manufacturer's recommendation for weight limits for towed equipment. Do not tow near ditches, canals, and other dangerous areas.

Operating

This machine is constructed only for mowing grass on lawns and even ground without obstacles such as stones, tree stumps, etc. The machine can also be used for other tasks when equipped with special accessories supplied by the manufacturer. Operating instructions for the accessories are supplied with delivery. All other types of uses are incorrect. The manufacturer's directions concerning operation, maintenance, and repairs must be carefully followed.

Lawn mowers and all power equipment, can be potentially dangerous if used incorrectly. Safety requires good judgment, careful use in accordance with these instructions and common sense.

The machine must only be operated, maintained, and repaired by persons who know the machine's special qualities and who are also knowledgeable about the safety instructions. Use only approved repair parts to maintain this machine.

Accident prevention regulations, other general safety regulations, occupational safety rules, and traffic regulations must be followed without fail.

Unauthorized modifications to the design of the machine can absolve the manufacturer from liability for resulting personal injury or damage to property.

INTRODUCTION

Good Service

Husqvarna's products are sold throughout the world and only in specialized retail stores with complete service. This ensures that you as a customer receive only the best support and service. Before the product is delivered, the machine has, for example, been inspected and adjusted by the retailer. See the certificate in the Service Journal in this operator manual.

When you need spare parts or support in service questions, warranty issues, etc., please consult the following professional:

This manual belongs to the machine with the manufacturing number:	Engine	Transmission

Manufacturing Number

The machine's manufacturing number can be found on the printed plate affixed to the engine compartment.

Stated on the plate, from the top are:

- The machine's type designation (I.D.)
- The manufacturer's type number (Model)
- The machine's serial number (Serial no.)

Please have the type designation and serial number available when ordering spare parts.

The engine's manufacturing number is stamped on one of the valve covers.

The plate states:

- The engine's model
- The engine's type
- Code

Please have these available when ordering spare parts.

The wheel motors and hydrostatic pumps have a barcode decal affixed at the rear.

SYMBOLS AND DECALS

These symbols are found on the machine and in the operator manual. Study them carefully so that you know what they mean.

IMPORTANT INFORMATION Xxxx xxxxxx
xxxxxx xxxx xxxxxxxxxxxx xxxxxx xxxxxxxxxxxx.

! WARNING! Xxxx xxxxxxx xxxxxx xxxxx
xxxxxxxxxxx xxxxxxx xxxxxxxxxxxx.

Used in this publication to tell the reader of a risk of personal injury or death, particularly if the reader neglects to follow the instructions in the manual.

Used in this publication to tell the reader of a risk of material damage, particularly if the reader neglects to follow the instructions in the manual. Used also when there is a possibility for misuse or misassembly.



Reverse

Neutral

Fast

Slow

Choke

Fuel

Park Brake



Danger

Cut Height
Low

Cut Height
High

Use protective
glasses

Use protective
gloves

Wear hearing
protection

Do not
stand here



Warning!
Battery acid is
corrosive, explosive
and flammable

Warning!
Do not touch parts

Warning!
Keep away from the
discharge deck

Warning!
Do not use without
deflector
or grass catcher

Read Operator
Manual

Shut off engine
before maintenance
or repair

Keep a safe
distance from
the machine

Use on slopes no
greater than 10°

No passengers

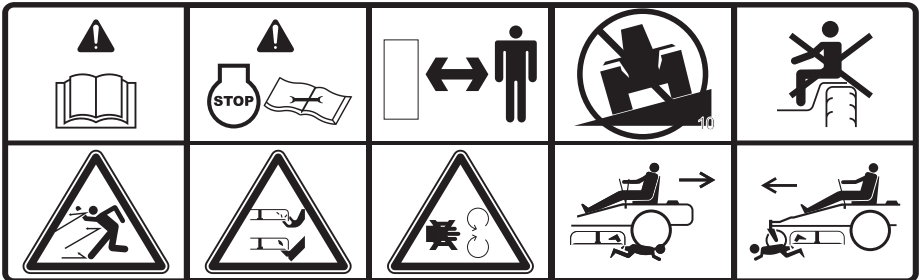

Full body
exposure to
thrown objects

Severing of fingers
and toes

Do not open or
remove safety
shields with engine
running

Careful backing up,
watch for
other persons

Careful going
forward, watch for
other persons

SAFETY

Safety Instructions

These instructions are for your safety. Read them carefully.

⚠ WARNING! THIS CUTTING MACHINE CAN AMPUTATE HANDS AND FEET AND THROW OBJECTS. FAILURE TO OBEY THE FOLLOWING SAFETY INSTRUCTIONS COULD RESULT IN SERIOUS INJURY OR DEATH.

⚠ WARNING! CHILDREN CAN BE SERIOUSLY INJURED OR KILLED BY THIS EQUIPMENT. Carefully read and obey all the safety instruction that follow.

IMPORTANT INFORMATION The American Academy of Pediatrics recommends that children be a minimum of 16 years of age before operating a riding lawn mower.

Protecting Children

Tragic accidents can occur if the operator is not alert to the presence of children. Children are frequently attracted to the machine and the mowing activity. **Do not** think that children will stay where you last saw them.

- Keep children out of the mowing area and in the watchful care of a responsible adult **other than** the operator.



- Be alert and turn machine off if a child enters the area.
- Before and while backing, look behind and down for small children.

- Do not carry children, even with the blades shut off. They can fall off and be seriously injured or interfere with safe machine operation. Children who have been given rides in the past can suddenly come into the mowing area to ride again and be run over or backed over by the machine.



- Do not let children to operate the machine.
- Use extreme care when going near blind corners, shrubs, trees, or other objects that can block your view of a child.

General Operation

- Read, understand, and obey all instructions on the machine and in the manual before starting.
- It is recommended that someone knows that you are mowing and can give aid if there is an injury or accident.
- Those who operate, maintain, and/or service this machine must first read and understand this Operator Manual. Local laws can regulate the age of the user. The owner is responsible for training the users of this equipment.
- The owner and operator of this equipment can prevent accidents and is responsible for accidents or injuries occurring to themselves, other persons and/or property.
- Do not put hands or feet near rotating parts or under the machine. Keep away from the discharge opening at all times.
- Only let responsible adults, who are familiar with the instructions, to operate the machine.

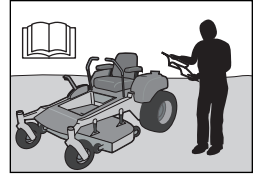

- Clean the area of objects such as rocks, toys, wire, etc., which could be picked up and thrown by the blades.
- Be sure the area is has no bystanders before operating. Stop machine if someone enters the area.
- Do not mow in reverse unless fully necessary. Always look down and behind before and while backing.
- Do not point discharged material toward someone. Avoid discharging material against a wall or obstruction. Material can ricochet back toward the operator. Stop the blades when going across gravel surfaces.
- Do not operate machine without the full grass catcher, discharge guard, or other safety devices in place and working.
- Slow down before turning.
- Always turn off blades, move the steering control lever out to the park brake position, stop engine and remove keys before dismounting.
- Do not carry passengers. The machine is only intended for use by one person.
- Operate the machine only in daylight or good artificial light.

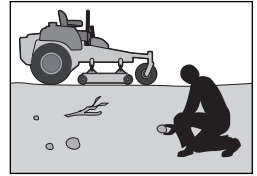

SAFETY

- Disengage blades when not mowing. Shut off engine and wait for all parts to come to a full stop before cleaning the machine, removing the grass catcher or unclogging the discharge guard.
- Do not operate the machine while under the influence of alcohol or drugs.
- Look for traffic when operating near or going across roadways.
- Use more care when loading or removing the machine into a trailer or truck.
- Always wear eye protection when operating machine.

⚠ WARNING! When using the machine, approved personal protective equipment must be used. Personal protective equipment cannot remove the risk of injury but it will reduce the degree of injury if an accident does occur. Speak to your retailer for aid in choosing the right equipment.

- Wear correct Personal Protective Equipment (PPE) while operating this machine, including (at a minimum) sturdy footwear, eye protection, and hearing protection. Do not mow in shorts and/or footwear with open toes.
- Data shows that operators age 60 years and above are involved in a large percentage of riding mower-related injuries. These operators must evaluate if they can safely operate the riding mower sufficiently to protect themselves and others from serious injury.
- Obey the manufacturer's recommendation for wheel weights or counterweights.
- Keep machine free of grass, leaves or other debris buildup which can touch hot exhaust or engine parts and burn. Do not let the mower deck plow leaves or other debris that can cause a buildup to occur. Clean oil or fuel spillage before operating or storing the machine.
- Let machine cool before storage.

Personal Safety Equipment

- Make sure that first aid equipment is near at hand when using the machine.
- Do not use the machine when barefoot.
- Always wear protective shoes or boots. Steel toe caps are recommended.

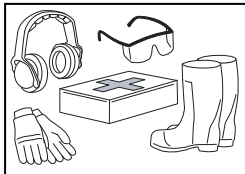

- Always wear approved protective glasses or a full visor when assembling or driving.
- Always wear gloves when handling the blades.
- Do not wear loose clothing that can become caught in moving parts.
- Use ear protectors to avoid damage to hearing.

Slope Operation

Slopes are a major cause related to loss of control and tip-over accidents, which can result in severe injury or death. Operation on slopes requires more care. If you cannot back up the slope or if you feel uneasy on it, do not mow it.

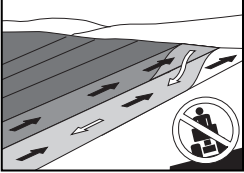
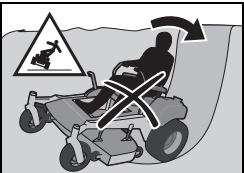
- Mow up and down slopes (10 degrees maximum), not across. 
- Look for holes, ruts, bumps, rocks, or other hidden objects. Uneven terrain could overturn the machine. Tall grass can hide obstacles.
- Select a low ground speed so it will not be necessary to stop while on the slope.
- Do not mow on wet grass. Tires can lose traction.
- Avoid starting, stopping, or turning on a slope. If the tires lose traction, disengage the blades and continue slowly straight down the slope.
- Move slowly and gradually on slopes. Do not make sudden changes in speed or direction, which could cause machine to roll over. 
- Use more care while operating machine with grass catchers or other attachments; the stability of the machine can be effected.
- Do not use on steep slopes.
- Do not try to stabilize the machine by putting a foot on the ground.
- Do not mow near drop-offs, ditches, or embankments. The machine could suddenly roll over if a wheel is over the edge or the edge caves in.

⚠ WARNING! Do not drive up or down hills with slopes greater than 10 degrees. Do not drive across slopes.

SAFETY

Safe Handling of Gasoline

To avoid personal injury or damage to property, use care in handling gasoline. Gasoline is very flammable and the vapors are explosive.

⚠ WARNING! The engine and the exhaust system become very hot during operation. There is a risk for burns if touched. Let engine and exhaust system to cool before refueling.

- Do not fuel the machine indoors.
- Extinguish all cigarettes, cigars, pipes, and other sources of ignition.
- Use only approved gasoline containers.
- Do not remove gas cap or add fuel with the engine running. Let engine cool before refueling.
- Do not keep the machine or fuel container where there is an open flame, spark or pilot light such as on a water heater or other appliance.
- Before you start refueling, keep the risk of static electricity to a minimum by touching a metal surface.
- Do not fill containers in a vehicle or on a truck or trailer bed with plastic liner. Always put containers on the ground away from the vehicle when filling.
- Do not put too much fuel in the tank. Replace gas cap and tighten securely.
- Remove gas-powered equipment from the truck or trailer and refuel it on the ground. If this is not possible, refuel such equipment with a portable container, rather than from a gasoline dispenser nozzle.
- Keep the nozzle in contact with the rim of the fuel tank or container opening at all times until fueling is complete. Do not use a nozzle lock-open device.
- If fuel is spilled on clothing, change clothing immediately.
- Do not start the engine near spilled fuel.
- Do not use gasoline as a cleaning agent.
- If leaks occur in fuel system, the engine must not be started until problem has been resolved.
- Check the fuel level before each use and leave space for the fuel to expand, because the heat from the engine and the sun can otherwise cause the fuel to expand and overflow.



General Maintenance

- Do not use the machine indoors or in spaces lacking correct ventilation. The exhaust fumes contain carbon monoxide, an odorless and poisonous lethal gas.

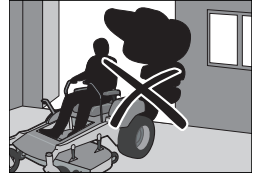

- Make sure that the equipment is in good condition and that all nuts and bolts, especially those fastening the blade attachments, are correctly tightened and torqued.



CAUTION! Use protective glasses for maintenance work.

- Maintain or replace safety and instruction labels as necessary.
- Do not interfere with the intended operation of or reduce the protection given by a safety device. Check their operation regularly. DO NOT operate a machine with a safety device that does not operate correctly.
- Check grass catcher components and the discharge guard frequently and replace with manufacturer's recommended parts when necessary.



WARNING! The engine must not be started when the driver's floor plate or protective plates for the mower deck's drive belt is removed.

- Do not change the settings of engine controllers and avoid running the engine at overly high engine speeds. If you run the engine too fast, machine components could be damaged.
- To reduce the risk of fire, keep machine free of grass, leaves or other debris buildup. Clean oil or fuel spills and remove fuel-soaked debris. Let machine cool before storing.
- Stop to do an inspection of the equipment if you run over or into anything. If necessary, make repairs before starting.
- Do not make adjustments or repairs with the engine running.
- The blades are sharp and can cause cuts and gashes. Wrap blades or use protective gloves when handling them.
- Check the park brake's operation regularly. Adjust and service as necessary.
- Do not work with the starter circuit if there is spilled fuel.

SAFETY

- Make sure that the fuel filler cap is mounted tightly and no flammable substances are kept in an open vessel.
- Sparking can occur when working with the battery and the heavy cables of the starter circuit. This can cause battery explosion, fire or eye injury. Sparking will not occur after the grounding cable (normally negative, black) is removed from the battery.
- Disconnect the grounding cable from the battery first and reconnect it last.
- Do not make a bridge short circuit across the starter relay to run the starter.
- Be very careful when handling battery acid. Acid on skin can cause serious corrosive burns. If you spill battery acid on your skin, rinse immediately with water.
- Acid in the eyes can cause blindness, contact a doctor immediately.
- Be careful when servicing the battery. Explosive gases form in the battery. Do not do maintenance on the battery when smoking or near open flames or sparks. The battery can explode and cause serious injury or damage.
- The machine is tested and approved only with the equipment originally supplied or recommended by the manufacturer. Only use approved repair parts for the machine.
- The mulch blades must only be used in familiar areas when higher quality mowing is necessary.
- Regularly clean the deck and the underside of the deck. Avoid spraying engine and electrical components with water.

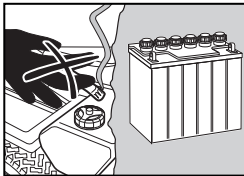

- Check and abide by local traffic regulations before transporting the machine on roads.
- Use an approved trailer to transport the machine. Turn off the fuel supply. Fasten the machine down with approved devices such as bands, chains or straps.
- Do not tow this machine, it can cause damage to the drive system.
- Do not tow trailers, etc. with this mower. They can jackknife or overturn, causing damage to the mower and possible serious injury to the operator.
- Load the unit onto truck or trailer by driving up ramps of sufficient strength using a slow speed. Do not lift! The machine is not intended to be lifted by hand.
- When loading or removing this machine, do not use more than the maximum recommended operation angle of 10 degrees.

WARNING! Use extreme care when loading the machine into a truck or trailer using ramps. There is the possibility of serious injury or death if the machine falls off the ramps.

IMPORTANT INFORMATION The park brake is not sufficient to lock the machine in place during transport. Make sure the machine is correctly fastened to the transport vehicle. Always reverse the machine onto the transport vehicle to avoid tipping it over.

Spark Arrestor

This mower is equipped with an internal combustion engine and must not be used on or near unimproved forested, bush covered or grassy lands unless the engine's system is equipped with a spark arrestor meeting applicable local or state laws. Federal laws apply on federal lands. If a spark arrestor is used, it must be maintained in good working order by the operator. A spark arrestor for the muffler is available through your authorized Husqvarna dealer.

Transport

- The machine is heavy and can cause serious crushing injuries. Be more careful when it is loaded on or removed from a vehicle or trailer.
- Use full width ramps for loading machine into a trailer or truck.
- The two front and rear tie down straps must be used and directed down and out from the machine.

CONTROLS

This operator manual describes the Husqvarna Zero Turn Rider. The rider is fitted with a four-stroke overhead valve engine.

Transmission from the engine is made via belt-driven hydraulic pumps. Using the left and right steering controls, the flow is regulated and thereby the direction and speed.

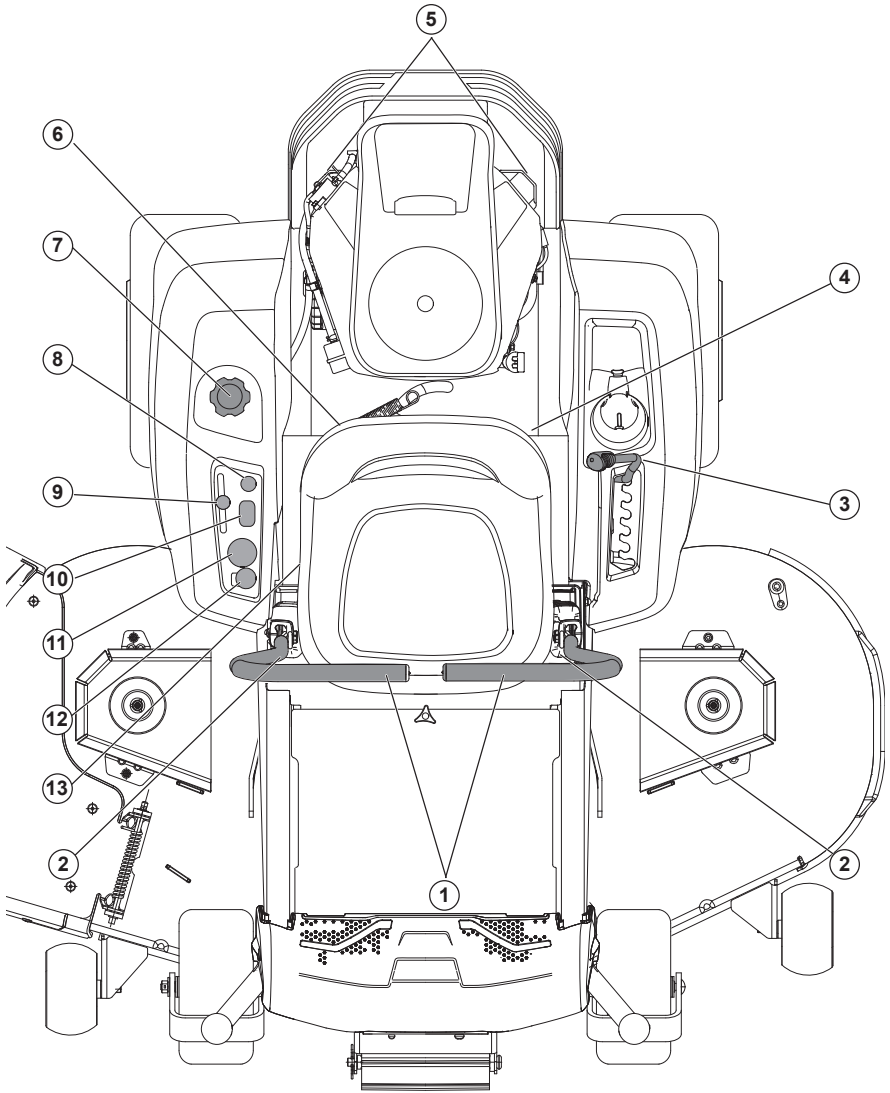

- | | | |
|-----------------------------------|------------------------|---------------------|
| 1. Steering / park brake controls | 5. Bypass Linkages | 10. Service meter |
| 2. Tracking bolts | 6. Fuel shut off valve | 11. Ignition switch |
| 3. Deck lift | 7. Fuel tank | 12. Blade switch |
| 4. Fuses | 8. Choke control | 13. Seat Adjustment |
| 9. Throttle Control | | |

CONTROLS

Steering Control Levers

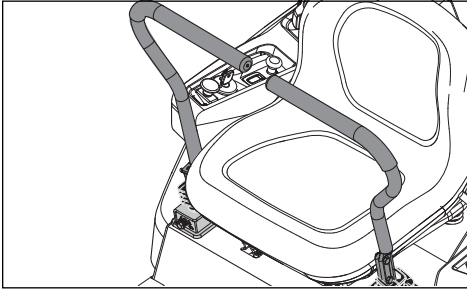

The machine's speed and direction are continuously variable using the two steering controls. The steering controls can be moved forward or backward about a neutral position. There is a neutral position, which is locked if the steering controls are moved out.

When both controls are in the neutral position (N), the machine stands still.

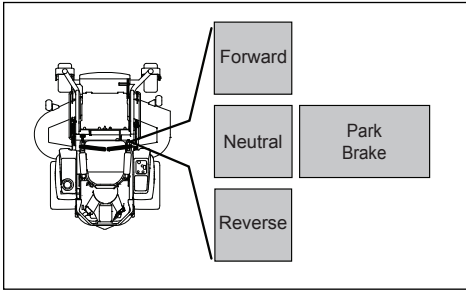

By equally moving both controls forward or backward, the machine moves in a straight line forward or backward. For example, to turn right while moving forward, move the right control towards the neutral position. The rotation of the right wheel is reduced and the machine turns to the right.

Zero turn can be achieved by moving one control backward (behind the neutral position) and carefully moving the other steering control forward from its neutral position. The rotation direction when zero turning is determined by which steering control is moved backward behind the neutral position. If the left steering control is pulled backward, the machine turns to the left. Use more care when using this maneuver.

If the steering controls are in uneven positions when standing still or do not fit in the slots for moving the controls out, they can be adjusted.

WARNING! The machine can turn very rapidly if one steering control is moved much further forward than the other.

Park Brake

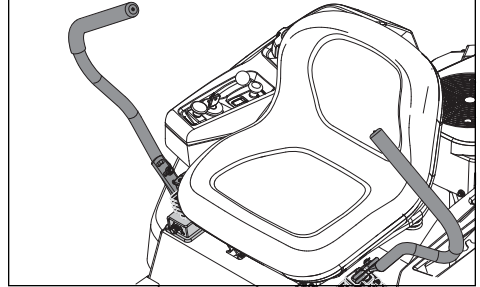

The park brake is integrated with the steering control levers. Move **both** levers out from the neutral position to engage the park brake.

To release the park brake, pull both steering control levers inwards to the neutral position at the same time. Do not try to operate the unit without both levers being inwards out of the engaged position or machine components could be damaged.

IMPORTANT INFORMATION Failure to bring the steering / park brake controls inwards at the same time will cause the unit's safety system to shut the unit down.

Throttle Control

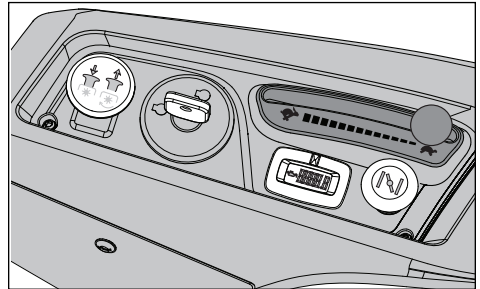

The throttle control regulates the engine speed and thereby the rate of rotation of the blades, assuming the blade switch is pulled out.

To increase or decrease the engine speed, the control is moved forward or back respectively.

Avoid idling the engine for long periods, as there is a risk of fouling the spark plugs. **USE FULL THROTTLE WHEN MOWING**, for best mower performance and battery charging.

CONTROLS

Ignition Switch

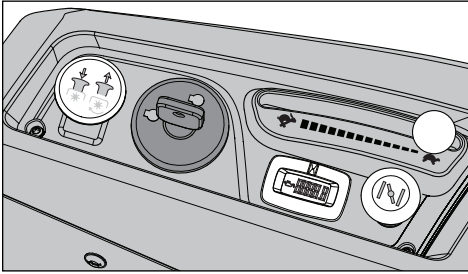

The ignition switch is placed on the control panel and is used to start and stop the engine.

Service Meter

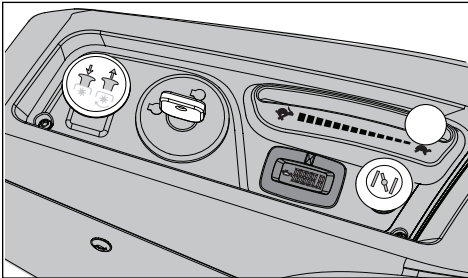

The service meter displays the total number of hours the engine has run and indicates when the engine and mower need servicing.

After every 50 hours of operation, an oil can icon will appear and stay on for two hours, before an automatic reset occurs. To manually reset the meter, turn the key off and on five times at one second intervals. To service the engine and mower, see the Service Journal of this manual.

NOTE: The service meter operates (clocks hours) only when the ignition is on. Be sure to turn the key off when the unit is not in use, to prevent meter hours from accumulating.

Blade Switch

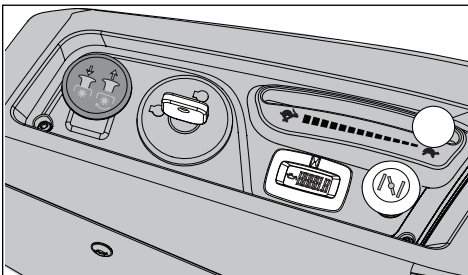

To engage the mower deck, pull the knob out; mower blades are disengaged when the knob is pressed down.

Choke Control

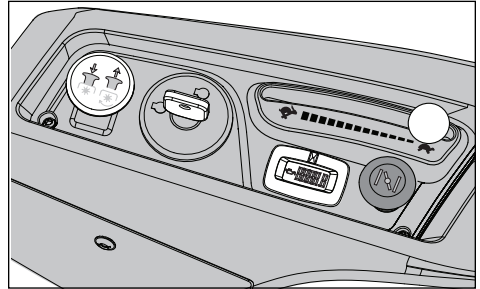

The choke control is used for cold starts to provide the engine with a richer fuel mixture. For cold starts, pull the control up.

Fuse

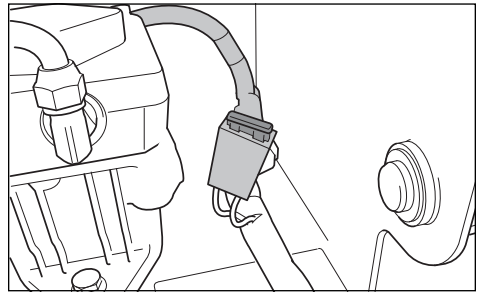

The 20 amp primary fuse is located on the left hand side of the machine. It is accessed by tilting the seat forward. The fuse is a flat pin type used in automobiles.

Cutting Height Lever

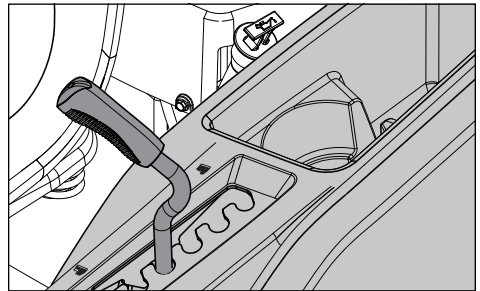

To set the deck cutting height, pull the cutting height lever inwards and move it to the desired height notch.

IMPORTANT INFORMATION Always raise the deck to the highest position for transport.

IMPORTANT INFORMATION To obtain an even cutting height, it is important that the air pressure in all tires is 103 kPa / 1 bar / 15 psi.

CONTROLS

Seat Adjustment Lever

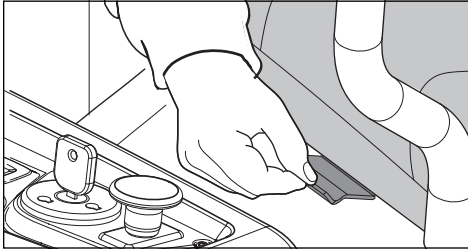

The seat can be adjusted lengthways. When making adjustments, the lever below the right side of the seat is pulled up, after which the seat can be moved backward or forward.

Bypass Linkages

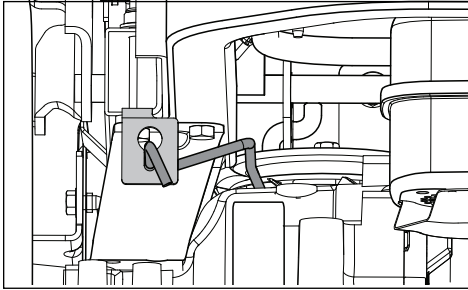

Transaxle bypass linkages must be engaged when pushing or pulling the mower. The release levers are located on each side of the rear of the unit below the rear engine guard. See **Moving Machine By Hand** in the *Operation* section.



WARNING! Bypass linkages are located close to the muffler. To prevent burns, the engine should be shut off and allowed to cool before the bypass linkage levers are handled.

Fuel Shut Off Valve

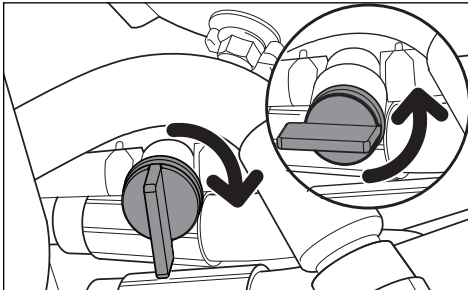

The fuel shut off valve is located at the right rear of the seat. The valve is off when the handle tab is turned perpendicular to the fuel line.

Tracking

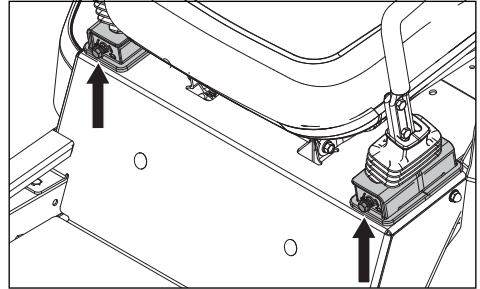

If the mower is not tracking straight, check the air pressure in both rear tires. Recommended air pressure for the rear tires is 103 kPa (15 psi).

1. Tracking adjustments are made using the tracking bolts. The tracking bolts limit the motion control levers when in the full-forward position.
2. For preliminary tracking adjustment, move unit to an open, unobstructed area such as an empty parking lot or open field.
3. Using a 1/2" wrench, back the tracking bolts out until flush with nut.
4. Test operate unit by driving it at full throttle and the full forward position on both motion control levers. Gradually turn in the tracking bolt on the right hand side until the unit noticeably starts drifting right.
5. Drive forward at full throttle with both motion control levers in the full forward position. Gradually turn in the left tracking bolt until unit tracks straight.

CONTROLS

WARNING! The engine and the exhaust system become very hot during operation. There is a risk for burns if touched. Let engine and exhaust system to cool before refueling.

WARNING! Fill to bottom of filler neck. Do not overfill. Clean off spilled oil or fuel. Do not store, spill or use gasoline near an open flame.

Fuel Tank

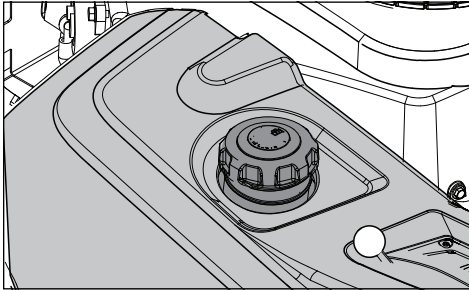

Read the safety instructions before refueling. The capacity for the tank is 13.25 litres (3-1/2 gallons).

Regularly check the gas cap gasket for damage and keep the cap correctly tightened.

The engine will operate on a minimum of 87-octane unleaded gasoline (no oil mix). Environmentally adapted alkylate gasoline can be used. See Technical Data concerning ethanol fuel. Methanol fuel is not allowed. Do not use E85 alcohol based fuel. Damage to the engine and components may occur.

When operating in temperatures below 0°C (32°F), use fresh, clean winter grade gasoline to help insure good cold weather starting.

WARNING! Gasoline is highly flammable. Observe caution and fill the tank outdoors (see **Safe Handling of Gasoline** in the Safety section).

IMPORTANT INFORMATION Experience indicates that alcohol blended fuels (called gasohol, ethanol or methanol) can attract moisture which leads to separation and formation of acids during storage. Acidic gas can damage the fuel system of an engine while in storage. To avoid engine problems, the fuel system should be emptied before storage of 30 days or longer. Drain the gas tank, start the engine and let it operate until the fuel lines and carburetor are empty. Use fresh fuel the next season. See **Storage** for additional information. Do not use engine or carburetor cleaners in the fuel tank or permanent damage may occur.

OPERATION

Read the *Safety* section and following pages if you are unfamiliar with the machine.

Training

Due to unique steering capabilities, zero turn mowers are far more maneuverable than typical riding mowers.

Review this section fully prior to trying to move the mower under its own power. When first operating the mower or until becoming comfortable with controls, use a reduced throttle speed and reduced ground speed. DO NOT move control levers to the furthest forward or reverse positions during initial operation.

First time users must become familiar with the mower's movement on a hard surface, such as concrete or blacktop PRIOR to trying to operate on turf. Until the operator becomes comfortable with the mower controls and zero turning capability, overly aggressive maneuvers may damage turf.

Steering

To move forward and backward

The direction and speed of the mower's movements are effected by the movement of the control lever(s) on each side of mower. The left control lever controls the left wheel. The right control lever controls the right wheel.

First time users must push the mower (see **Moving Machine By Hand** in the *Operation* section) to an open, flat area without other persons, vehicles or obstacles nearby. To move the unit under its own power, the operator must sit in the seat and start the engine (see **Before Starting** in the *Operation* section). Adjust the engine speed to idle, disengage the park brake but do not engage the blades at this time. Pull control levers inward. As long as the control levers have not been moved forward or backwards, the mower will not move.

Slowly move both control levers forward slightly. This will let the mower start moving forward in a straight line. Pull the control levers back to the neutral position and stop the mower from moving.

Pull back slightly on control levers, allowing the mower to move backwards. Push the control levers forward to the neutral position to stop the mower from moving.

To turn to the right

While moving in a forward direction, pull the right lever back towards the neutral position while maintaining the position of the left lever, this will slow the rotation of the right wheel and cause the machine to turn in that direction.

To turn to the left

While moving in a forward direction pull the left lever back towards the neutral position while maintaining the position of the right lever, this will slow the rotation of the left wheel and cause the machine to turn in that direction.

To zero turn

While moving in a forward direction, first pull both control levers back until the mower stops or slows dramatically.

Then by alternating one lever slightly to the forward position and the other in the reverse position, complete the turn.

Before Starting

⚠ WARNING! Make sure the work area is free from stones and other objects that could be thrown by the rotating blades.

1. Read the sections on *Safety* and *Controls* before starting the machine.
2. Do the daily maintenance before starting (see **Maintenance Schedule** in the *Maintenance* section).
3. Check that there is sufficient fuel in the fuel tank.
4. Adjust the seat to the desired position.

⚠ WARNING! The engine exhaust contains carbon monoxide, which is a odorless, colorless, poisonous gas. Do not use the machine in enclosed spaces.

Starting the Engine

1. Sit on the seat.
2. Raise the mower deck to the highest position.

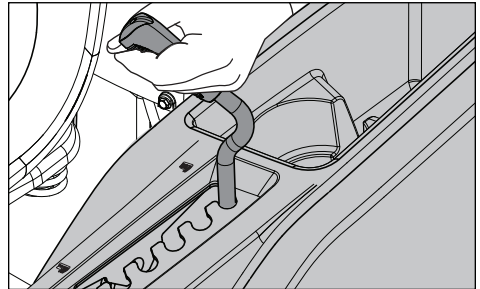

3. Disengage the mower blades by pressing the blade switch down.
4. Move the steering / park brake controls firmly out to the locked position.
5. Move the throttle lever to the middle throttle position. If the engine is cold, the choke control should be pulled up.

OPERATION

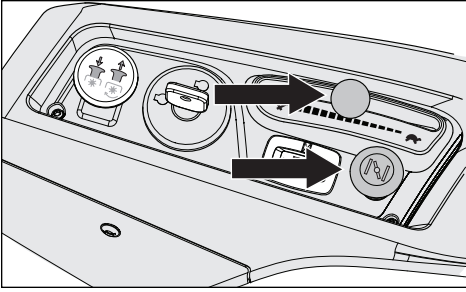

6. Push in and turn the ignition key to the start position.

IMPORTANT INFORMATION Do not operate the starter for more than five seconds each time. If the engine does not start, wait approximately ten seconds before retrying.

7. When the engine starts, immediately release the ignition key back to the run position. Slowly push the choke control in, if it was used to start a cold engine.
8. Set the engine speed with the throttle. Let the engine to operate at a moderate speed, approximately mid throttle, for a short time before use. **USE FULL THROTTLE WHEN MOWING** (no choke).

Running

1. Release the park brake by pulling the steering / park brake controls inwards to the neutral position at the same time.

NOTE: The mower is equipped with an operator presence system. If the operator tries to leave the seat with the engine running, without first setting the park brake, the engine will shut off.

2. Lower the mower deck to the desired cutting height.

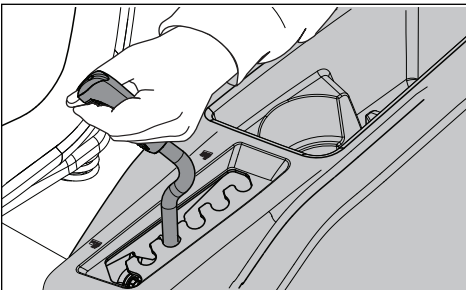

3. Move throttle control to full throttle (rabbit symbol).
4. Engage the mower deck by pulling the blade switch up.

WARNING! Make sure that no one is near mower when engaging blade switch.

5. Pull control levers inward and slowly move both control levers slightly forward to move forward in a straight line.

Stopping the Engine

1. Move the throttle to the minimum position (tortoise symbol).
2. Move the steering controls at the same time out to the park brake position.
3. Disengage the mower deck by pressing the blade switch down.
4. Raise the mower deck to the highest position. If the engine has been worked hard, let it idle at least 60 seconds to attain a usual operating temperature before stopping. To prevent fouling the spark plugs, avoid idling the engine for longer periods.
5. Turn the ignition key to the stop position. Remove key. Always remove key when leaving the mower to prevent unauthorized use.

IMPORTANT INFORMATION When stopping and leaving the machine, both steering / park brake controls must be moved out to the locked position at the same time.

IMPORTANT INFORMATION Leaving the ignition switch in a position than OFF will cause the battery to be discharged.

Operating on Hills

Read the Safety Instructions **Driving on Slopes** in the Safety section.

- Use the slowest speed possible before starting up or down hills.
- Avoid stopping or changing speed on hills.
- If stopping is fully necessary, pull steering / park brake controls into the neutral position and push outward to engage the park brake.
- Pull the steering / park brake controls back to the center of the mower and push forward to regain forward movement.
- Make all turns slowly.

WARNING! Do not drive the rider on terrain that slopes more than 10 degrees. Mow slopes up and down, never side to side. Avoid sudden directional changes. Do not drive across slopes.

OPERATION

Mowing Tips

- Observe and flag rocks and other fixed objects to avoid collisions.
- Begin with a high cutting height and reduce it until the desired mowing result is attained. The average lawn must be cut to 6.35 cm (2-1/2") during the cool season and over 7.62 cm (3") during the hot months. For healthier and better looking lawns, mow often after moderate growth.
- For best cutting performance, grass over 15.24 cm (6") in height must be mowed twice. Make the first cut relatively high; the second to the desired height.
- The mowing result will be best with a high engine speed (the blades rotate rapidly) and low speed (the rider moves slowly). If the grass is not too long and dense, the driving speed can be increased without negatively affecting the mowing result.
- The finest lawns are obtained by mowing often. The lawn becomes more even and the grass clippings more equally distributed over the mown area. The total time taken is not increased as a higher operating speed can be used without poor mowing results.
- When mowing large areas, start by turning to the right so that clippings will discharge away from shrubs, fences, driveways, etc. After one or two rounds, mow in the opposite direction making left hand turns until finished.

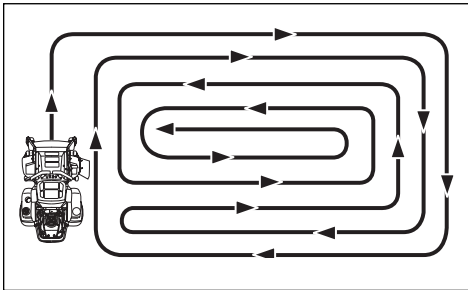

- Avoid mowing wet lawns. The mowing result is poorer because the wheels sink into the soft lawn, clumps build, and grass clippings fasten under the cowlings.
- Hose the mower deck underside with water after each use. When cleaning, the mower deck shall be raised into the transport position. Make sure the mower is cooled and the engine is off.
- Use compressed air to clean top surface of the deck. Avoid flooding water on top surface, engine and electrical components.

- When the mulching kit is used, it is important that the mowing interval is frequent.



WARNING! Make no adjustments without:

- the engine stopped,
- the ignition key removed,
- the park brake activated

Moving Machine By Hand

When pushing or pulling the mower, engage the EZT bypass linkages. The EZT bypass linkages are located on the rear of the frame, below the rear engine guard.

1. Raise the deck into the highest cutting position.
2. Move the steering / park brake controls inwards to the neutral position.
3. Pull the EZT bypass linkages up and out of the keyhole slots. Release the levers with the head outside the frame and held in the bypass position.

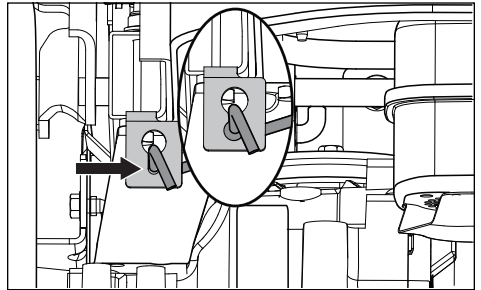

4. To reengage the EZT's to drive, reverse the above procedure.

Load the machine into truck or trailer by driving slowly up the ramps. **DO NOT LIFT!** The machine is not intended to be lifted by hand.

IMPORTANT INFORMATION To manually push the mower, engage the hydro bypass levers on both sides, pull both steering / park brake controls inwards and push machine.



WARNING! Bypass linkages are located close to the muffler. To prevent burns, the engine should be shut off and allowed to cool before the bypass linkage levers are handled.



WARNING! Use more caution when loading the machine into a truck or trailer using ramps. There is the possibility of dangerous injury or death if the machine falls off the ramps.

MAINTENANCE

Maintenance Schedule

Following is a list of maintenance procedures that must be performed on the machine. For those points not described in this manual, visit an authorized service workshop. An annual service

carried out by an authorized service workshop is recommended to maintain the machine in the best possible condition and to make sure of safe operation.

Read **General Maintenance** in the *Safety* section.

MAINTENANCE	DAILY		AT LEAST ONCE EACH YEAR	MAINTENANCE INTERVAL IN HOURS			
	BEFORE	AFTER		25	50	100	300
CHECK							
Park brake for adjustment	●						
Engine's oil level (each refueling)	■						
Safety system	●						
For fuel and oil leakages	◆						
For damage		◆					
For loose hardware (screws, nuts)		◆					
For mower deck damage		◆					
Tire pressures				●	●	●	●
Battery connections			●	●	●	●	●
CLEAN							
Engine's cooling air intake		■		■			
Below the mower deck		●					
Around the engine		◆					
Around belts, belt pulleys		◆			◆	◆	◆
Engine's cooling air intake ²⁾			■	■			
Air cleaner foam pre-filter ²⁾			■	■			
Air cleaner paper filter cartridge ²⁾			■	■			
ALSO							
Inspect muffler/spark arrestor			◆		◆	◆	◆
Start the engine & blades, listen for unusual sounds		◆					
Sharpen ³⁾ / Replace mower blades			●	●			

● = Described in this manual

◆ = Not described in this manual

■ = Refer to the engine manufacturer's manual

- 1) First change after 8-10 hours. When operating with a heavy load or at high ambient temperatures, replace at 50 hour intervals.
- 2) In dusty conditions, cleaning and replacement are required more frequently.
- 3) Performed by authorized service workshop.



WARNING! Before performing service or adjustment:

- Engage the park brake.
- Disengage the blade switch.
- Turn the ignition switch to OFF position and remove the key.
- Make sure the blades and all moving parts have completely stopped.

MAINTENANCE

MAINTENANCE	DAILY		AT LEAST ONCE EACH YEAR	MAINTENANCE INTERVAL IN HOURS			
	BEFORE	AFTER		25	50	100	300
CHECK							
Throttle cable for adjustment						■	
Mower deck for adjustment			●				●
Condition of belts, belt pulleys			●			●	
Caster wheels (at 200 hour intervals)			●			●	
Engine valve clearance ³⁾			◆				◆
CHANGE							
Spark plugs			■			■	
Engine oil ¹⁾			■	■			
Engine oil filter			■			■	
Fuel filter			■			■	
Paper air filter ²⁾			■			■	
Air cleaner foam pre-filter ^{2) 4)}			■				
Air cleaner paper filter cartridge ^{2) 4)}			■				
ALSO							
Do the 300-hour service ³⁾			◆				◆

- = Described in this manual
- ◆ = Not described in this manual
- = Refer to the engine manufacturer's manual

¹⁾ First change after 8-10 hours. When operating with a heavy load or at high ambient temperatures, replace at 50 hour intervals.

²⁾ In dusty conditions, cleaning and replacement are required more frequently.

³⁾ Performed by authorized service workshop.

⁴⁾ If equipped.

IMPORTANT INFORMATION The mower is equipped with a 12-volt negative grounded system. The other vehicle must also be a 12-volt negative grounded system. Do not use the mower to start other vehicles.



CAUTION! Always wear eye protection when around batteries.



WARNING! Do not short battery terminals by allowing a wrench or other objects to contact both terminals at the same time. Before connecting battery, remove metal bracelets, wristwatch bands, rings, etc.

Positive terminal must be connected first to prevent sparks from accidental grounding.

MAINTENANCE

Battery

If the battery is too weak to start the engine, it must be recharged.

Jumper Cable Use

1. Connect each end of the RED cable to the POSITIVE (+) terminal on each battery, taking care not to short against chassis.
2. Connect one end of the BLACK cable to the NEGATIVE (-) terminal of the fully charged battery.
3. Connect the other end of the BLACK cable to a good CHASSIS GROUND on the mower with the discharged battery, away from the fuel tank and battery.

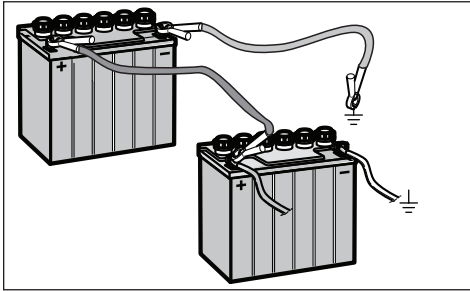

To remove cables, reverse order

1. Remove BLACK cable first from chassis and then from the fully charged battery.
2. Remove RED cable last from both batteries.

The mower is equipped with a maintenance free battery and does not need servicing. However, periodic charging of the battery with an automotive type battery charger will extend its life.

- Keep battery and terminals clean.
- Keep battery bolts tight.
- See chart for charging times.

STD BATTERY	STATE OF CHARGE	APPROXIMATE CHARGING TIME* TO FULL CHARGE AT 80°F			
		Maximum Rate at:			
		50 Amps	30 Amps	20 Amps	10 Amps
12.6V	100%	- FULL CHARGE -			
12.4V	75%	20 min.	35 min.	48 min.	90 min.
12.2V	50%	45 min.	75 min.	95 min.	180 min.
12.0V	25%	65 min.	115 min.	145 min.	280 min.
11.8V	0%	85 min.	150 min.	195 min.	370 min.

*Charging time depends on battery capacity, condition, age, temperature and efficiency of charger

Cleaning battery and terminals

Corrosion and dirt on the battery and terminals can cause the battery to lose power.

1. Loosen the two nuts attached to the side J bolts just enough that the battery mount bracket slides down off the battery.

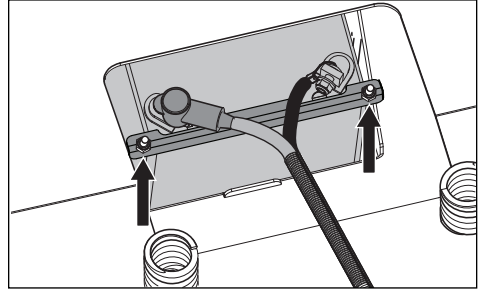

2. Using two 1/2" wrenches disconnect BLACK battery cable then RED battery cable.
3. Carefully remove the battery from the mower
4. Rinse the battery with plain water and dry.
5. Clean terminals and battery cable ends with a wire brush until shiny.
6. Coat the terminals with grease or petroleum jelly.

Replacing battery

1. Install the new battery with terminals in the same position as the old battery.
2. Connect RED battery cable first to positive (+) battery terminal.
3. Connect BLACK grounding cable to negative (-) battery terminal.
4. Slide mount bracket back up over battery and tighten nuts.
5. Replace terminal boot cover.

IMPORTANT INFORMATION Do not open or remove battery caps or covers. Adding or checking level of electrolyte is not necessary. Always use two wrenches for the terminal screws.

CAUTION! Lead-acid batteries generate explosive gases. Keep sparks, flame and smoking materials away from batteries. Always wear eye protection when around batteries.

MAINTENANCE

Safety System

The machine is equipped with a safety system that prevents starting or driving under the following conditions.

The engine can only be started when:

- the mower deck is disengaged.
- the steering / park brake controls are in the outer, locked neutral position, making sure of full parking brake engagement for a safe startup.

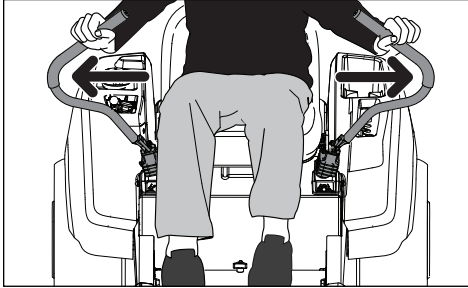

NOTE: If the steering / park brake controls are not holding in the full outboard position, the tension can be adjusted by tightening the nut on the backside of the pivot. (See Park Brake in this section).

Make daily inspections to make sure that the safety system works by trying to start the engine when one of the conditions is not met. Change the conditions and try again.

If the machine starts when one of these conditions is not met, turn the machine off and repair the safety system before using the machine again.

Make sure the engine stops when the park brake is not engaged and the operator leaves the seated position.

Check that the engine stops if the mower blades are engaged and the driver temporarily moves off the drivers seat.

IMPORTANT INFORMATION To be able to drive, the driver must sit in the seat and the steering / park brake controls must be moved into the engaged (outer) position. Otherwise the engine will stop.

Park Brake

Visually check that no damage is found on the steering control levers, links or switches belonging to the park brake. Do a standstill test and check that there is sufficient braking action.

To adjust the park brake tension, move the boot covering the steering control base. Tighten the 1/2" pivot nut until the braking action is correct.

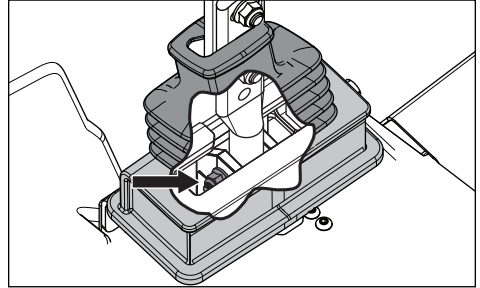

Replace the steering boot, making sure the boot top sits between the two adjustment bolts on the steering control.

For any further adjust to the park brake, contact the Husqvarna service workshop.

IMPORTANT INFORMATION The machine must be standing still when applying the park brake.

WARNING! Faulty adjustment will result in reduced braking ability and can cause an accident.

Tire Pressures

All tires must be at 103 kPa / 1 bar / 15 psi.

IMPORTANT INFORMATION DO NOT add a tire liner or foam fill material to the tires. Excessive loads created by foam filled tires will cause premature failures.

Only use O.E.M. specified tires.

MAINTENANCE

Caster Wheels

Check at 200 hour intervals. Check that wheels turn freely. If wheels do not turn freely take the unit to a dealer for service.

Foam filled tires or solid tires will void the warranty.

Removal and installation

Remove nut and caster bolt. Pull the wheel out of the yoke and take care of the spacers. Install in reverse order. Tighten caster bolt.

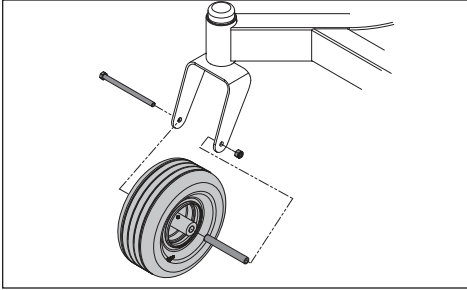

V-belts

Check at 100 hour intervals of operation. Check for severe cracking and large nicks.

NOTE: The belt will show some small cracks in usual operation.

The belts are not adjustable. Replace belts if they begin to slip from wear.

Deck Belt Removal

1. Park on a level surface. Engage park brake.
2. Lower the deck into the lowest cutting position.
3. Remove the bolts from the belt shields and remove the shields.
4. Remove dirt or grass from around the cutter housings and the deck surface.
5. Push inward on the idler arm to release the tension on the belt.

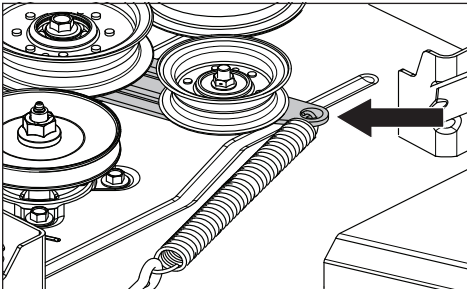

6. Carefully lift the belt over the top of the cutter housing pulleys and remove belt from the deck.

Deck Belt Installation

NOTE: For ease in installing the deck belt, refer to the routing decal on the top of the deck.

1. Wind the deck belt around the electric clutch pulley located on the engine shaft.
2. Route the belt forward and up onto the deck.
3. Position the belt around spring loaded idler pulley.
4. Wind the belt around the stationary idler pulley and the mandrel housings.
5. Push inward on the idler arm and carefully put the belt over the stationary idler pulley. When the belt is correctly routed, slowly release the idler arm to tension the belt.
6. Check the belt routing to make sure it matches the routing decal and the belt does not have twists.
7. Tighten the belt guide
8. Replace the belt shields.

Adjusting the Mower Deck

Leveling deck

Adjust the deck while the mower is on a level surface. Make sure the tires are inflated to the correct pressure. If tires are under or over inflated, the deck cannot be correctly adjusted. Raise the deck to the highest (transport) position. The deck must be adjusted slightly higher in the rear.

NOTE: To insure the precision of the leveling procedure, the mower deck drive belt must be installed before leveling the deck.

1. Wear heavy gloves. Turn each outer blade tip to align front to rear with the deck side-to-side.

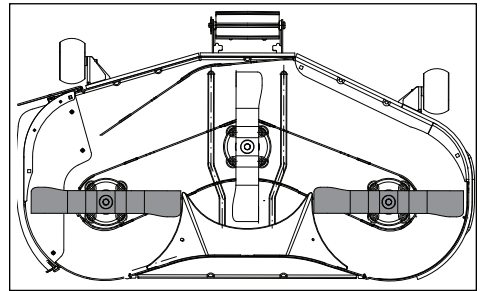

2. Measure from the floor surface up to the bottom of the blade tip on the discharge side of the mower deck. Record the measurement.

MAINTENANCE

3. Move to the opposite side, check that measurement is the same. If adjustment is required—with a 3/4" or adjustable wrench, turn the lift link adjustment nuts on either side counter clockwise to lower or clockwise to raise. Adjust until both measurements are equal.

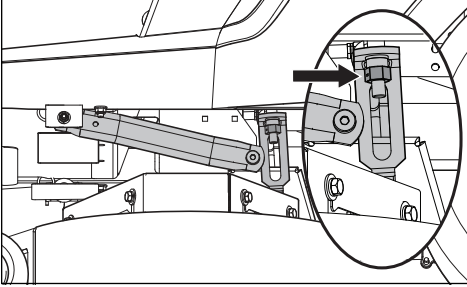

4. Turn any blade to align with the deck front-to-rear. If the front blade tip does not measure 6.4 mm to 9.5 mm (1/4" to 3/8") lower than the rear— with a 5/8" or adjustable wrench, turn the nuts on the front suspension linkage. Clockwise raises the front of the mower, counter clockwise will lower the front. Adjust nuts until rear of mower deck is positioned level to 3.2 mm (1/8") higher in the rear than the side-to-side measurement.

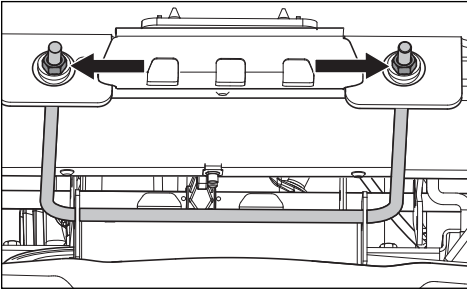

NOTE: This will position the mower deck in a standard measurement position. Depending on the type of grass being mowed or environmental conditions, additional adjustments may be required to get the desired cut.

Cutting Blades

⚠ CAUTION! Blades are sharp. Protect your hands with gloves and/or wind heavy cloth around the blades before handling.

The sharpening of blades must be carried out by an authorized service workshop.



For the best mowing results, it is important that blades are correctly sharpened and not damaged. Replace blades that have been bent or cracked when hitting obstacles.

Let the service workshop decide if a blade with large nicks can be repaired/ground or must be replaced. Balance the blades after sharpening. Check the blade mounts.

Blade replacement

1. Remove blade bolt by turning counter clockwise.
2. Install new or resharpened blade with stamped GRASS SIDE facing towards ground/grass (down) or THIS SIDE UP facing deck and cutter housing.
3. Seat the blade's opening firmly onto the cutter housing.
4. Tighten blade bolt securely.
5. Torque blade bolt to 60–75 Nm (45–55 ft-lb).

IMPORTANT INFORMATION Special blade bolt is heat treated. Replace with a Husqvarna bolt if required. Do not use lower grade hardware than specified.

MAINTENANCE

Anti-scalp Rollers

Anti-scalp rollers are correctly adjusted when they are slightly off of the ground when the deck is at the desired cutting height in the operating position. Anti-scalp rollers keep the deck in the proper position to help prevent scalping in most terrain conditions.

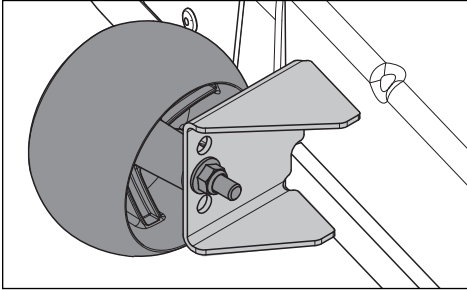

The anti-scalp rollers can be set in three positions:

- Upper: 1-1/2" to 2-1/2" (38 mm to 63 mm) grass
- Middle: 2-1/2" to 4" (63 mm to 102 mm) grass
- Lower: 4" to 6" (102 mm to 152 mm) grass

The rollers must be approximately 6.4 mm (1/4") from the ground.

Cleaning

Regular cleaning, especially under the mower deck, will increase the machine's life-span. Clean the machine directly after use (after it is cooled), before the debris sticks.

Do not spray water on the top of the mower deck. Use compressed air to clean the top side of the mower deck. Do not use a high pressure washer or steam cleaner. Avoid spraying engine and electrical components with water.

Clean the underside of the deck with normal water pressure. Attach the quick connect (from the accessory packet) to any garden hose. After mowing, snap the hose to the cleanout port and turn on water supply.

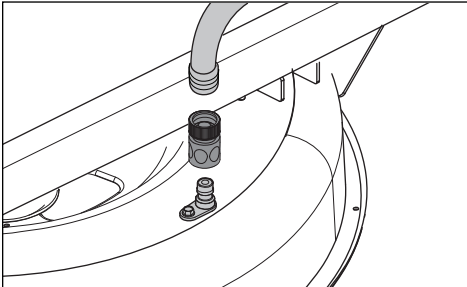

Restart the mower and engage the blades to use the spinning action to wash away debris. Make sure the hose is away from the mower blades.

Do not rinse hot surfaces with cold water. Let unit cool before washing.



CAUTION! Use protective glasses when cleaning and washing.

Hardware

Check daily. Inspect the entire machine for loose or missing hardware.

LUBRICATION

12/12	1/52	1/365		25h	50h	100h	200h	300h	
				1 ← (2x)					
				2 ← (2x)					
				3 ← ← (2x)					
				4 ▼			▼		
	▼	👁️		4				🔋	
12/12	Every year			Lubricate with grease gun ←					
1/52	Every Week			Filter change 🔋					
1/365	Every day			Oil change ▼					
				Level check 👁️					

General

Remove the ignition key to prevent unintentional movements during lubrication.

When lubricating with an oil can, it must be filled with engine oil.

When lubricating with grease, unless otherwise stated, use a high grade molybdenum disulphide grease.

For daily use, the machine must be lubricated twice weekly.

Clean away unwanted grease after lubrication.

It is important to avoid getting lubricant on the belts or the drive surfaces of the belt pulleys. If this happens, try to clean them with spirits. If the belt continues to slip after cleaning, the belt must be replaced. Gasoline or other petroleum products must not be used to clean belts.

IMPORTANT INFORMATION Use minimal lubrication and remove excess lubricant so that it does not come into contact with belts or belt pulley drive surfaces.

⚠️ WARNING! Escaping hydraulic oil under pressure can have sufficient force to penetrate the skin, causing dangerous injury. If injured by escaping fluid, see a doctor immediately. Dangerous infection or reaction can develop if proper medical treatment is not administered.

LUBRICATION

Engine Oil

NOTE: Change the engine oil when the engine is warm. Refer to the engine owner's manual for the correct replacement oil and filter change recommendations.

⚠ WARNING! The engine drain plug is located close to the muffler. To prevent burns, the engine should be shut off and allowed to cool slightly so the engine is still warm but the surrounding surfaces and oil are not.

1. Park on a level surface. Apply park brake.
2. Clean the dirt and debris from the area around the oil fill cap.
3. Remove the cap/dipstick.
4. Locate the drain hose at the right rear of the engine near the bypass linkage.

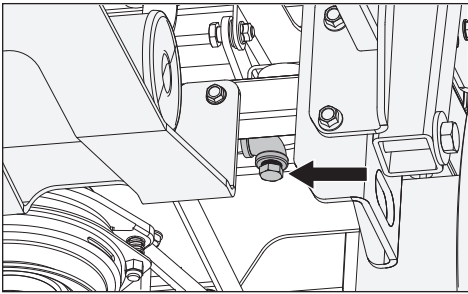

5. Place an adequately sized container under the end of the drain hose and remove the oil drain plug.
6. Let the oil to fully drain from the engine.
7. Replace the drain hose plug and tighten securely.
8. Fill the engine with new oil to the bottom of the fill tube threads. Check the level with the dipstick.
9. Replace the oil fill cap securely when the oil level is FULL.
10. Refer to the Service Journal for oil checking and changing intervals.

Wheel and Deck Zerk

Use only good quality bearing grease. Grease from well-known brand names (petrochemical companies, etc.) usually maintains a good quality.

Front Wheel Mount

Lubricate 3–4 strokes with a grease gun on each set of wheel bearings.

Front Wheel Bearings

Lubricate 3–4 strokes with a grease gun on each set of wheel bearings.

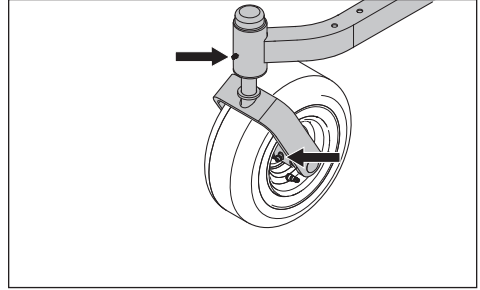

Deck Spindles

Lower the cutting deck completely. Lubricate with a grease gun, 2–3 strokes per spindle through the openings in the belt shields.

If a grease gun without rubber hose is used, the foot plate must be removed to access the center spindle.

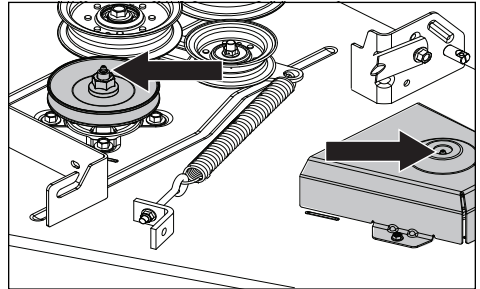

Transmission

The transmission is maintenance free with no need for level checks or oil changes. If a leak occurs, replace the unit or contact your Husqvarna dealer.

TROUBLESHOOTING

Problem / Cause

Engine will not start

- Blade switch is engaged
- Steering controls are not locked in the neutral position
- Park brake is not engaged
- Dead battery
- Contamination in the carburetor or fuel line
- Fuel supply shutoff valve is closed or in the wrong position
- Clogged fuel filter or fuel line
- Ignition system faulty

Starter does not turn the engine over

- Dead battery
- Battery terminal cable contacts are defective
- Blown fuse
- Fault in the starter safety circuit. See **Safety System** in the *Maintenance* Section

Engine runs rough

- Faulty carburetor
- Clogged fuel filter or jet
- Throttle lever in the Cold Weather starting position
- Clogged ventilation valve on the fuel cap
- Fuel tank nearly empty
- Fouled spark plugs
- Rich fuel mixture or fuel-air mixture.
- Wrong fuel type
- Water in fuel
- Clogged air filter

Engine seems weak

- Clogged air filter
- Fouled spark plugs
- Carburetor incorrectly adjusted
- Air trapped in hydraulic system

Machine vibrates

- Blades are loose
- Blades are incorrectly balanced
- Engine is loose

Engine overheats

- Clogged air intake or cooling fins
- Engine overloaded
- Poor ventilation around engine
- Defective engine speed regulator
- Too little or no oil in the engine
- Contamination in the fuel line
- Fouled spark plugs

Battery not charging

- Battery terminal cable contacts are defective
- Charging lead is disconnected
- Fault in engine charging system

Mower moves slowly, unevenly, or not at all

- Park brake engaged
- Bypass linkage engaged
- Transmission drive belt is slack or off
- Air trapped in hydraulic system

Mower deck not engaging

- Drive belt for the mower deck is loose
- Electromagnetic coupling contact is loose
- Blade switch is faulty or loose from cable contact
- Blown fuse

Transaxle leaks oil

- Damaged seals, housing, or gaskets
- Air trapped in hydraulic system

Uneven mowing results

- Unequal air pressures in tires
- Bent blades
- Suspension for the mower deck is uneven
- Blades are dull
- Driving speed too high
- Grass is too long
- Grass has collected under the mower deck

STORAGE

Winter Storage

The machine should be readied for storage at the end of the mowing season or if it will not be in use for more than thirty days. Fuel allowed to stand for long periods of time (thirty days or more) can leave sticky residues that can clog the carburetor and disrupt engine function.

Fuel stabilizers are an acceptable option to prevent the sticky residues that can occur during storage.

Add stabilizer to the fuel in the tank or in the storage container. Always use the mixing ratios specified by the manufacturer of the stabilizer. Operate the engine for at least ten minutes after adding the stabilizer so that it reaches the carburetor. Do not empty the fuel tank and the carburetor if stabilizer has been added.



WARNING! Do not store an engine with fuel in the tank indoors or in poorly ventilated spaces where fuel vapor can come in contact with open flames, sparks, or a pilot light such as in a boiler, hot water tank, clothes dryer, etc. Handle the fuel with care. It is very flammable and can cause dangerous personal injury and property damage. Drain the fuel into an approved container outdoors and store far away from open flame or sources of ignition. Do not use gasoline for cleaning. Use a degreaser and warm water.

To ready the machine for storage:

1. Thoroughly clean the machine, especially below the mower deck. Touch up damage to the paint and spray a thin layer of oil on the underside of the mower deck to avoid corrosion.
2. Inspect the machine for worn or damaged parts and tighten any nuts or screws that may have become loose.
3. Change the engine oil; dispose correctly.
4. Empty the fuel tanks or add a fuel stabilizer. Start the engine and let it operate until the carburetor is drained of fuel or the stabilizer has reached the carburetor.
5. Remove the spark plug and put about a tablespoon of engine oil into the cylinder. Turn over the engine so that the oil is evenly distributed and then refit the spark plug.
6. Lubricate all grease zerks, joints and axles.
7. Remove the battery. Clean, charge and store the battery in a cool area and protected from direct cold.
8. Store the machine in a clean, dry area and cover it for more protection.

Service

When ordering spare parts, please specify the purchase year, model, type, and serial number.

Always use genuine Husqvarna spare parts.

An annual check-up at an authorized service workshop is a good way to make sure that the machine performs its best the following season.

SCHEMATIC

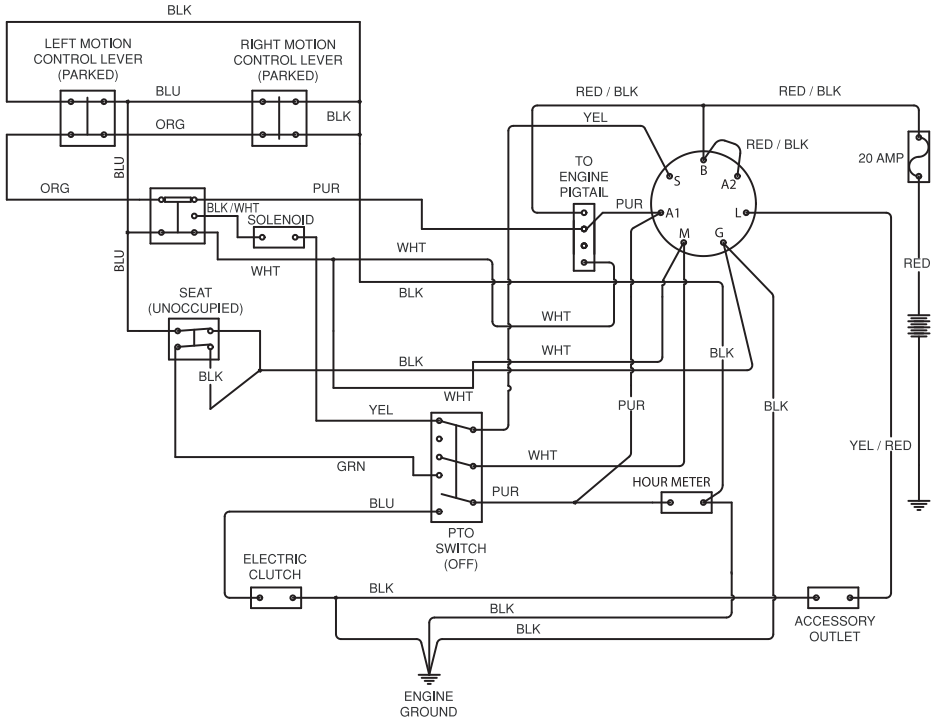

KEY SWITCH POSITIONS

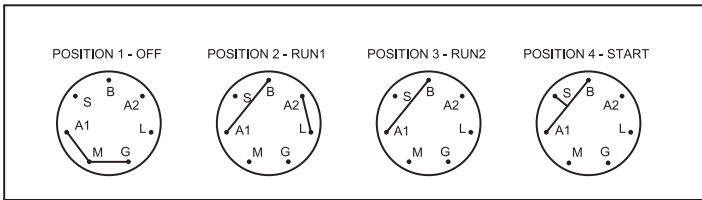

TECHNICAL DATA

ENGINE		
Manufacturer	Kawasaki	
Type	FR730V	
Power	17.9 kW ¹⁾	24 hp ¹⁾
Lubrication	Pressure with oil filter	
Fuel	Min 87 octane unleaded (Max ethanol 10%, Max MTBE 15%)	
Fuel tank capacity	13.25 litres	3-1/2 gallons
Cooling	Air cooled	
Air filter	Standard	
Alternator	12v 15 amp @ 3600 rpm	
Starter	Electric	
TRANSMISSION		
Transmission	Hydrostatic transaxles	
Steering control	Dual levers, foam gripped	
Speed forward	0–10.5 km/h	0–6.5 mi/h
Speed reverse	0–5.6 km/h	0–3.5 mi/h
Brakes	Integrated Mechanical Park Brake	
Front caster tires	11 x 6-5	
Rear tires, turf pneumatic	18 x 9.5-8	
Tire pressure	103 kPa / 1 bar / 15 psi	
FRAME		
Cutting Width	137 cm	54"
Cutting Height	3.8 cm – 10.2 cm	1-1/2" – 4"
Number of Blades	3	
Blade Length	46.4 cm	18-1/4"
Anti-scalp roller	6 adjustable	
Sprung Seat	Standard	
Hinged Arm Rests	Optional	
Service Meter	Digital	
Blade Engagement	Ogura Clutch	
Deck Construction	10 gauge fabricated	
Productivity	11,311 m ² /h	2.8 acres/h
DIMENSIONS		
Weight	290 kg	640 lb
Base Machine Length	191 cm	75"
Base Machine Height	102 cm	40"
Base Machine Width	112 cm	43-3/4"
Overall Width, Chute Up	145 cm	57"
Overall Width, Chute Down	172 cm	67-1/2"

¹⁾ The power rating as declared by the engine manufacturer is the average gross power output at the specified RPM of a typical production engine for the engine model measured using SAE Standards for engine gross power. Refer to the engine manufacturer engine specifications.

TECHNICAL DATA

Torque Specifications

Engine crankshaft bolt	50 ft-lb	Standard 1/4" fasteners	9 ft-lb
Lug nuts	75 ft-lb	Standard 5/16" fasteners	18 ft-lb
Blade bolts	55 ft-lb	Standard 3/8" fasteners	33 ft-lb
Mandrel nuts	75 ft-lb	Standard 7/16" fasteners	52 ft-lb
Mandrel bolts	20 ft-lb	Standard 1/2" fasteners	80 ft-lb

HEX HEAD CAP SCREWS

The torque values shown should be used as a general guideline when specific torque values are not given.

U.S. Standard Hardware

Grade		SAE Grade 5		SAE Grade 8		Flangelock Screw w/Flangelock Nut	
Size		ft-lb	Nm	ft-lb	Nm	ft-lb	Nm
Shank Size (Diameter in inches, fine or coarse thread)	1/4	9	12	13	18		
	5/16	18	24	28	38	24	33
	3/8	31	42	46	62	40	54
	7/16	50	68	75	102		
	1/2	75	102	115	156		
	9/16	110	149	165	224		
	5/8	150	203	225	305		
	3/4	250	339	370	502		
	7/8	378	512	591	801		
	1-1/8	782	1060	1410	1912		

** Grade 5 - Minimum commercial quality (lower quality not recommended)

Metric Standard Hardware

Grade		Grade 8.8		Grade 10.9		Grade 12.9	
Size		ft-lb	Nm	ft-lb	Nm	ft-lb	Nm
Shank Size (Diameter in millimeters, fine or coarse thread)	M4	1.5	2	2.2	3	2.7	3.7
	M5	3	4	4.5	6	5.2	7
	M6	5.2	7	7.5	10	8.2	11
	M7	8.2	11	12	16	15	20
	M8	13.5	18	18.8	25	21.8	30
	M10	24	33	35.2	48	43.5	59
	M12	43.5	59	62.2	84	75	102
	M14	70.5	96	100	136	119	161
	M16	108	146	147	199	176	239
	M18	142	193	202	274	242	328
	M20	195	264	275	373	330	447
	M22	276	374	390	529	471	639
	M24	353	478	498	675	596	808
M27	530	719	735	996	904	1226	

SERVICE JOURNAL

DELIVERY SERVICE

Action	Date, mtr reading, stamp, sign
Charge and connect the battery	<input type="checkbox"/>
Adjust the tire pressure of all wheels to 103 kPa (15 psi)	<input type="checkbox"/>
Connect the contact box to the cable for the seat's safety switch	<input type="checkbox"/>
Check that the right quantity of oil is in the engine	<input type="checkbox"/>
Adjust the position of the steering controls	<input type="checkbox"/>
Fill with fuel and open the fuel shut off valve	<input type="checkbox"/>
Start the engine	<input type="checkbox"/>
Check:	
Drive to both wheels	<input type="checkbox"/>
Mower deck pitch and adjustment	<input type="checkbox"/>
Safety switch for the park brake	<input type="checkbox"/>
Safety switch for the mower deck	<input type="checkbox"/>
Safety switch in the seat	<input type="checkbox"/>
Safety switch in the steering controls	<input type="checkbox"/>
Park brake functionality and adjustment	<input type="checkbox"/>
Driving forward	<input type="checkbox"/>
Driving backward	<input type="checkbox"/>
Engaging the blades	<input type="checkbox"/>
Idle speed	<input type="checkbox"/>
Engine high idle speed	<input type="checkbox"/>
Inform the customer about:	
Need and advantages of following the service schedule	<input type="checkbox"/>
Need and advantages of leaving the machine for service	<input type="checkbox"/>
Effects of service and maintaining a service journal on the machine's resale value	<input type="checkbox"/>
Application areas for mulching	<input type="checkbox"/>
Fill in the sales papers, etc.	

Delivery service has
been carried out

No remaining notes

Certified:

SERVICE JOURNAL

AFTER 10 HOURS

Action	Date, mtr reading, stamp, sign
Change the engine oil	<input type="checkbox"/>

DAILY SERVICE

Action	Date, mtr reading, stamp, sign
Clean debris from mower	<input type="checkbox"/>
Check engine oil level	<input type="checkbox"/>
Check the tire pressures	<input type="checkbox"/>
Check underside of deck	<input type="checkbox"/>
Check safety system	<input type="checkbox"/>
Check fuel system for leaks	<input type="checkbox"/>
Inspect safety guards and shields	<input type="checkbox"/>
Check brake adjustment	<input type="checkbox"/>

25-HOUR SERVICE

Action	Date, mtr reading, stamp, sign
Check the fuel pump's air filter	<input type="checkbox"/>
Sharpen/Replace mower blades if required	<input type="checkbox"/>
Check the tire pressures	<input type="checkbox"/>
Check battery cables	<input type="checkbox"/>
Lubricate according to lubrication chart	<input type="checkbox"/>
Check/clean the engine's cooling air intake	<input type="checkbox"/>
Clean the air cleaner's foam pre-filter	<input type="checkbox"/>

50-HOUR SERVICE

Action	Date, mtr reading, stamp, sign
Do the 25-hour service	<input type="checkbox"/>
Clean / replace the air cleaner's paper filter cartridge (shorter intervals for dusty operating conditions)	<input type="checkbox"/>
Change engine oil	<input type="checkbox"/>
Lubricate according to lubrication chart	<input type="checkbox"/>

SERVICE JOURNAL

100-HOUR SERVICE

Action	Date, mtr reading, stamp, sign
Do the 25-hour service	<input type="checkbox"/>
Do the 50-hour service	<input type="checkbox"/>
Change the engine oil filter	<input type="checkbox"/>
Clean/replace the spark plugs	<input type="checkbox"/>
Replace the fuel filter	<input type="checkbox"/>
Check V-belts	<input type="checkbox"/>
Check / tighten caster wheel axle bolts (at 200 hour intervals)	<input type="checkbox"/>
Change the air filter's paper cartridge	<input type="checkbox"/>

300-HOUR SERVICE

Action	Date, mtr reading, stamp, sign
Do the 25-hour service	<input type="checkbox"/>
Do the 50-hour service	<input type="checkbox"/>
Do the 100-hour service	<input type="checkbox"/>
Check / adjust the mower deck	<input type="checkbox"/>
Clean the combustion chamber and grind the valve seats	<input type="checkbox"/>
Check the engine valve clearance	<input type="checkbox"/>
Replace the air cleaner's foam pre-filter	<input type="checkbox"/>

AT LEAST ONCE EACH YEAR

Action	Date, mtr reading, stamp, sign
Clean the engine's cooling air intake (at 25 hour intervals)	<input type="checkbox"/>
Replace the air cleaner's foam pre-filter (at 50 hour intervals)	<input type="checkbox"/>
Replace the air filter's paper cartridge	<input type="checkbox"/>
Change the engine oil (50 hours)	<input type="checkbox"/>
Replace the engine oil filter (100 hours)	<input type="checkbox"/>
Check / adjust the cutting height	<input type="checkbox"/>
Check / adjust the park brake (50 hours)	<input type="checkbox"/>
Clean / change the spark plugs (100 hours)	<input type="checkbox"/>
Change the fuel filter (100 hours)	<input type="checkbox"/>
Check the engine valve clearance	<input type="checkbox"/>



www.husqvarna.com

2019-04-25 SR